

EN



[T]

Angela TA Pro 8 kW, 10 kW, 12, 14 kW  
Angela Plus 8 kW, 10 kW, 12, 14 kW

---

**This MANUAL must be kept in a safe place for future reference and the instructions contained herein must be carefully considered before using the device.**

## TIPS

- This manual accompanies the unit you have purchased. It is intended for technicians who will install the stove and for users. **Caution!** Before installation and use, read the instructions in this manual carefully.
- Keep the manual in a safe place for future reference. If necessary, you can request a copy of this manual. If the device is resold, the manual must be given to the new user.
- **Caution!** The installation of the unit and the chimney, as well as maintenance work, must be carried out by a licensed, qualified installer.
- The installation of the device is the responsibility of the installer. The installer must check the chimney and the combustion air supply in the room and confirm that the relevant recommendations in this manual are feasible.
- **Caution!** The installer must use good working practices and the required Personal Protective Equipment when installing the appliance.
- **Warning!** Any installation or use of the stove in a manner other than that described in this manual, or the use of non-authorized spare parts exempts the company from any liability for possible damage to the device, persons, or objects.
- The installation and use of the stove must be carried out in accordance with national and European standards, the regulations and relevant laws applicable at the place of installation.
- At least one annual service should be carried out by an authorized partner to ensure proper maintenance of the unit.
- Before any cleaning or maintenance procedure, all devices must be disconnected from the power supply (ON/OFF switch). The company reserves the right to change these instructions for use without notice.

**The installer is responsible for the installation of the unit who is required to check the flue, the air intake duct, and the correct positioning of the device in accordance with applicable regulations.**

# CONTENTS

1.0	Technical Specifications .....	4
2.0	Safety Precautions .....	6
3.0	Installation Instructions .....	7
3.1	Placing the stove .....	7
4.0	Connecting to the flue .....	9
5.0	Technical characteristics of fuel .....	15
6.0	Maintenance and cleaning .....	16
6.2	Cleaning the combustion chamber .....	17
6.3	Glass cleaning .....	17
6.4	Moving and cleaning the ash container .....	18
6.5	Cleaning .....	19
6.6	Periodic cleaning of ANGELA air stove.....	19
6.6.1	Annual cleaning of ANGELA air heater.....	20
6.7	Cleaning schedule for accessories according to pellet usage.....	20
7.0	Electrical connections .....	21
8.0	Control Panel: Use and Functions .....	23
ERRORS FAULTS .....		24
Power On/Off .....		25
Combustion Power Adjustment.....		25
Room Temperature Adjustment (1).....		25
Manual Pellet Loading (2) .....		25
Pellet Feed Adjustment (3).....		26
Combustion Air Adjustment (3) .....		26
Display .....		27
User Menu (2).....		27
Date and Time Setting.....		28
Installation Instructions.....		30

## 1.0 Technical Specifications

### TYPE ANGELA - TECHNICAL SPECIFICATIONS

TYPE ANGELA	TA 8	TA 10	TA 12	TA 14
Power	3–8 kW	4–10 kW	5–12 kW	6–14 kW
Heated Area	≤ 50 m <sup>2</sup>	≤ 60 m <sup>2</sup>	≤ 80 m <sup>2</sup>	≤ 120 m <sup>2</sup>
Air Flow	400 m <sup>3</sup>	450 m <sup>3</sup>	450 m <sup>3</sup>	500 m <sup>3</sup>
Pellet Consumption	0.7–1.8 kg/h	0.8–2.3 kg/h	0.9–2.7 kg/h	1.0–3.2 kg/h
Weight	110 kg	115 kg	120 kg	120 kg
Pellet Tank Capacity	20 kg	25 kg	30 kg	30 kg
Combustion Autonomy	22 h	22 h	22 h	20 h
Flue Outlet	80 mm	80 mm	80 mm	80 mm
Length	450 mm	450 mm	450 mm	520 mm
Depth	550 mm	550 mm	550 mm	620 mm
Height	900 mm	950 mm	1000 mm	1050 mm

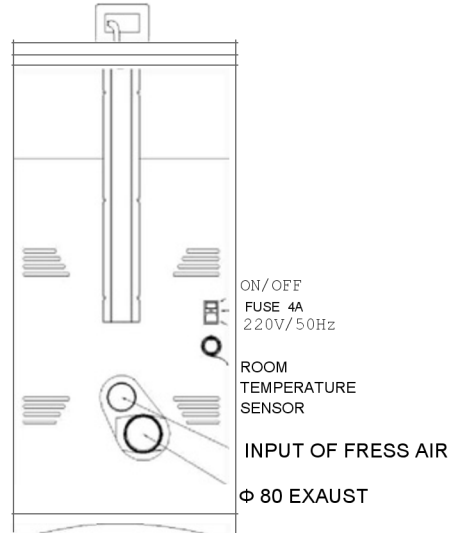
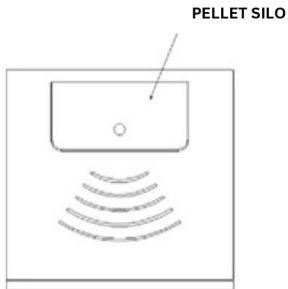
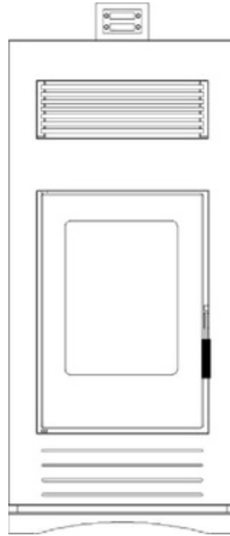



**The company is not liable if the product or any of its components are used incorrectly or modified without permission.  
All components must be replaced by original parts**

## 2.0 Safety precautions

**Fuel:** This stove is designed and approved for burning wood pellets (ash content  $\leq 2\%$ ). High ash content will adversely affect the operation and performance of the stove and may void the warranty. Contact your dealer for detailed fuel recommendations.



### **DO NOT USE WOOD IN THE PELLET STOVE**

**Soot:** During operation, insufficient combustion air will result in the formation of soot. If this occurs, the soot will accumulate on the glass, heat exchanger, and ventilation system. This situation is dangerous and reduces efficiency. For this reason, you should check the combustion chamber frequently and remove ashes and dust from the interior to ensure efficient combustion. If necessary, call your dealer to adjust the fan speed or feed rate.

**Cleaning:** There will be some ash and small amounts of tar in the exhaust pipe. This will vary depending on the quality of the pellets and the operation of the stove. It is recommended that you check and clean the ventilation system every six months or every time two tons of pellets have been used.

**Combustion:** To prevent ash from flying out, keep the door closed and sealed during combustion. The color of a normal flame is bright yellow, and the pellets burn with a small jump inside the container. There is no smoke escape. If the flame becomes darker and smoke appears, speed up the combustion fan to

add air intake. Do not block the ventilation pipe and air intake duct.



The operating mode is for cold weather conditions; please do not operate the stove when the weather is warm. Unauthorized modifications to the device are NOT permitted. Replacement parts must be replaced in accordance with the manufacturer's instructions.

### 3.0 Installation Instructions



**When installing the device, all national and local regulations and European standards must be observed. Otherwise, the device will not be covered by warranty.**

Before installation, choose the right location to ensure even and safe heating.

**The stove must not be installed in a bathroom or bedroom. The manufacturer is not liable in the event of an accident.**



**Warning! The device MUST NOT be installed by the user alone.**

#### 3.1 Placing the stove

It is recommended that the stove be placed near a chimney, in a relatively central location in the space to be heated, to facilitate even heat distribution and optimal stove performance. When the stove is placed in a room with flammable flooring (wood, plastic), it is recommended that it be placed on a special metal or glass base.

Place the stove at a safe distance from other flammable materials, no less than 40 cm from both the sides and the back. There is no need for a distance from the floor. However, it is recommended to use a metal or glass plate to protect the floor. In addition, the necessary space for stove maintenance must be taken into account.



**The stove should only be installed and maintained by an authorized technician. Do not attempt to repair the stove yourself. All national and local regulations must be observed when installing the appliance.**



**It is FORBIDDEN to use gasoline, kerosene, or similar liquids to light the stove. Such liquids must be kept away from the stove when it is lit. DO NOT install or light the stove for the first time without reading the manual. Any deviation from the instructions in the manual will void the warranty and may be dangerous.**



**Due to the high temperature, the stove must be located away from public areas and away from furniture and curtains. Children and adults should also be careful due to the high temperature of the stove surface. They should stay away to avoid burns or clothing ignition. Teenagers should be supervised when near the stove.**



**Any grills, panels, or glass that are removed for maintenance MUST be done after the power supply has been disconnected and the temperature has dropped completely. Do not operate the stove if the front glass has been removed, is cracked, or broken. The glass must be replaced by a qualified technician. Dealers, resellers, and the manufacturer will not be held responsible for**

any damage caused by improper operation, improper maintenance, improper installation that prevented the stove from being used normally, or any direct or indirect damage caused by unsafe conditions.

#### 4.0 Connection to the flue



**It is mandatory that the connection of the flue gas outlet be carried out by suitably qualified personnel and in accordance with the regulations in force.**

The connection of the flue/chimney is of utmost importance for the proper functioning of the stove. The exhaust gases must be extracted through a single pipe (A) or an existing flue that complies with the intended use (B). In both cases, there must be a cap (AT) or an opening (AP) for inspection. (Figure 4.1)

**The chimney must be stainless steel, insulated, and double-walled.** It is prohibited to connect more than one unit to the same flue. Unless there are national standards (such as in Germany) which, under appropriate conditions, allow the installation of multiple devices on the same fireplace. In any case, strictly follow the installation requirements of the relevant regulations/legislation in force in the country where the stove is installed.





Before installation, you must ensure that the internal cross-section and height of the flue allow for proper draft.

To ensure proper operation, avoid installing horizontal sections as they can fill with ash, reducing the intended cross-section.

In addition, a large number of bends should not be installed. The connection of the bends should generally be made in a stable manner to ensure maximum safety and minimize load losses.



**At the connection point of the flue pipes, the diameter must not be reduced in relation to the intended outlet of the unit by installing reducers.**

-  Do not open the appliance door when it is lit or in the process of closing.
-  Do not touch the appliance when it is switched on, as there is a risk of serious burns.
-  Do not use the flame of the stove or boiler to light cigarettes, candles, etc.
-  The use of flexible flues, especially aluminum ones, is prohibited as there is a risk of fire.

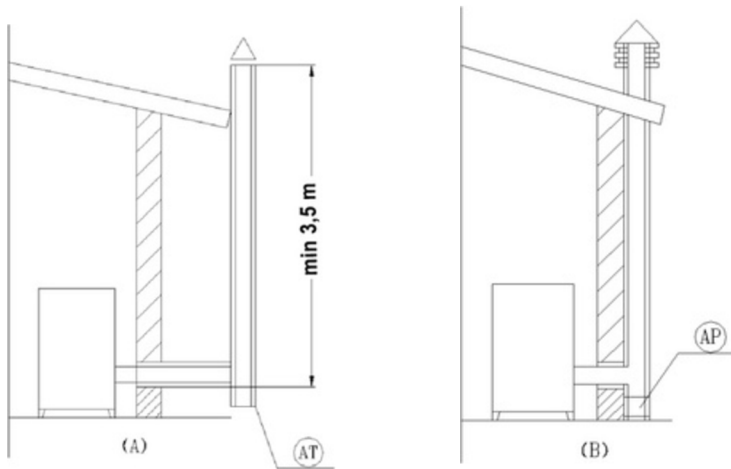
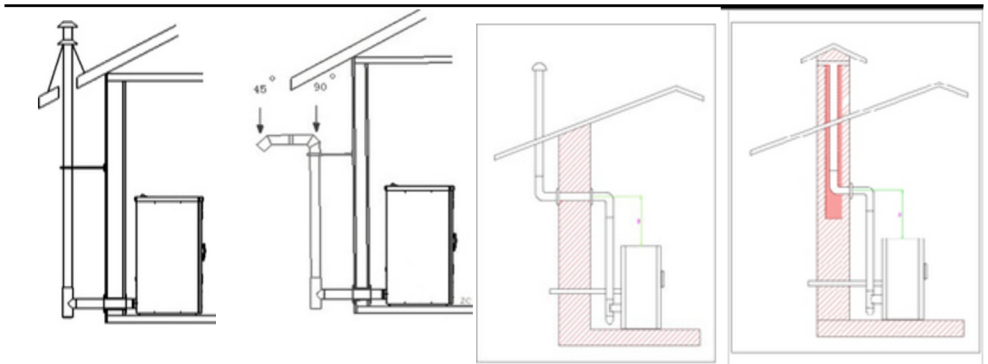

**Figure 4.1 Installation of vertical pipes**

**Note:** Pellet stoves must use a special flue pipe that has been installed and inspected by authorized and specialized personnel. Injury may result from improper installation of the flue pipe or failure to comply with local and national regulations. In this case, the manufacturer is not liable. When the exhaust gas extraction route is longer than 10 m and in conditions of reduced draft (presence of a large number of bends, long horizontal sections, unsuitable discharge terminals, etc.), exhaust extraction may not be optimal.

In this case, a **100 mm diameter** chimney is required (**especially for large machines over 40 kW**). Since the device can operate with low exhaust gas output below **120 °C**, an **insulated chimney is required** at the device outlet, as well as a cleaning trap with a condensate removal device.

If the device is installed indoors without an independent fresh air supply, it is necessary to connect the device to the fresh air inlet from the environment with a duct. (Figure 3.2)



**Figure 4.2 Examples of chimney installation**

When installing horizontal chimney sections, ensure that there is a slight slope of approximately **5°** towards the cleaning trap.

The flue must be resistant to high temperatures, thermally insulated, sealed, durable for long-term use, and not easily damaged. It should be properly insulated on the outside to prevent condensation and reduce smoke cooling.

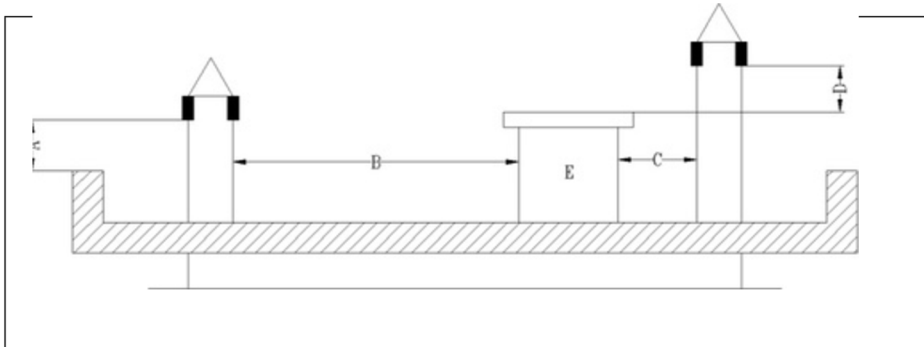

**A=0.50 m**  
**B=distance > 2 m**  
**C= distance < 2 m**

**D=0.50 m**  
**E=House chimney**

**Figure 4.3**

**Roof 15°**

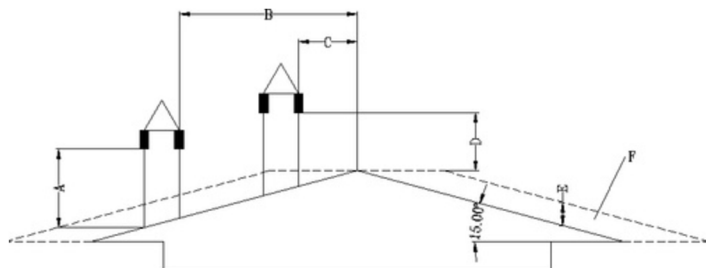

**A=Min 1.00 m**  
**B= distance > 1.85 m**  
**C= distance < 1.85 m**

**D=0.50 m above the highest point**  
**E=0.50 m**

**Figure 4.4**

**30° roof**

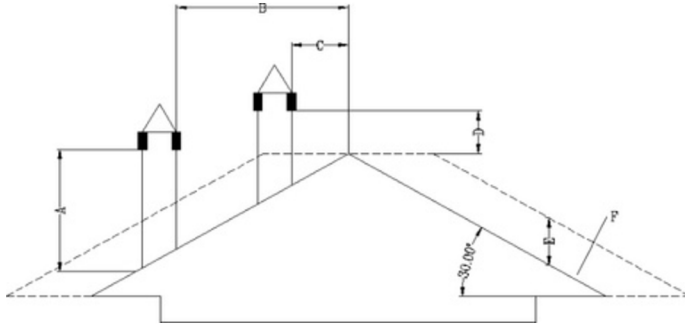

**A=Min 1.30 m**  
**B= distance > 1.50 m**  
**C= distance < 1.50 m**

**D=0.50 above the highest point**  
**E=0.80 m**

**Figure 4.5**

**60° roof**

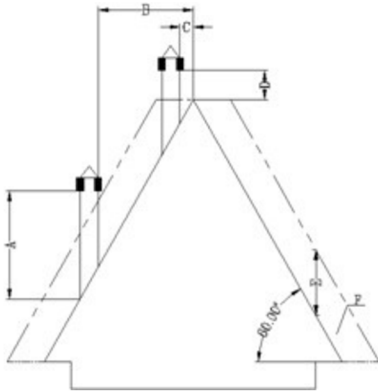

**A=Min 2.60 m**  
**B= distance > 1.50 m** **C= distance < 1.50 m**  
**D=0.50 above the highest point**  
**E=0.80 m**

**Figure 4.6**

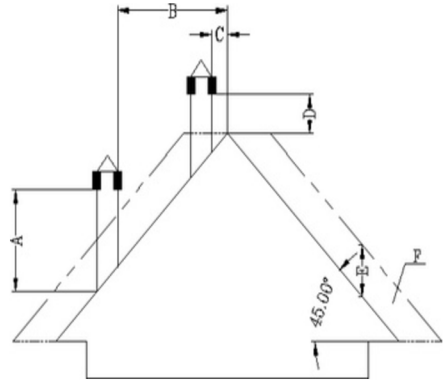

**A=Min 2.00 m**  
**B= distance > 1.30 m** **C= distance < 1.30 m**  
**D=0.50 m above the highest point**  
**E=2.10 m**

**Figure 4.7**

The exhaust gas outlet can be connected to a flue on the wall with an outlet above the roof (exhaust outlet **Ø 80 mm**, with only one **90°** bend) or to a chimney outside the wall (exhaust outlet **Ø 80 mm**, with two **90°** bends each). The exhaust gas outlet must have as few bends as possible and be raised at least two meters to ensure natural draft in the event of a malfunction of the exhaust fan or a power failure. The correct operation of the unit varies depending on the installation. The manufacturer is not liable if the device does not meet the specifications stated by the manufacturer in the event of incorrect installation. Installation should be carried out using pipes with internal silicone seals (gaskets), special supports, and cleaning plugs.

It is necessary:

- There must be a suitable air intake opening
- The horizontal sections must have a slope of **>5°** and a length of **<2 m**
- The vertical section must have a height **> 2.5 m**
- The flue (connection to the exhaust outlet) must be accessible
- It is recommended to seal the connection between the flue and the exhaust outlet with adhesive or other sealant resistant to high temperatures
- It is recommended to have an ash collector.
- The grates of the combustion air supply duct must be positioned so that they cannot become blocked.
- It is prohibited to place a damper on the duct
- Do not place the flue outlet in enclosed or semi-enclosed spaces, such as bridges, garages, attics, narrow corridors, narrow enclosed areas under terraces, or any location where smoke accumulates, such as stairwells, etc.

- **A carbon monoxide detector, smoke detector, chimney cap, and fire extinguisher must be installed.**
- **If there are other devices that require an air supply, the relevant instructions for those devices must also be followed devices regarding the supply of the appropriate amount of air to prevent exhaust fumes from escaping from the stove.**

## 5.0 Fuel technical characteristics

**Pellets** are a product consisting of various types of wood that have been compressed through mechanical processes and in accordance with environmental protection regulations. **Pellets** are a product made from various types of wood, wood residues or by-products, or even agricultural residues, e.g. cereal residues (straw), corn residues, cotton residues, rice residues, etc.

The devices we refer to operate efficiently and without problems, consuming only wood **pellets** with maximum efficiency and minimum maintenance.

The efficiency and thermal capacity of the unit may vary depending on the type and quality of **the pellets**.

For best performance, we recommend using **pellets** with the following characteristics:

Diameter  $\approx$  **6 mm**

	Length $\approx$ <b>30 mm</b>	Maximum moisture content <b>8-9%</b>
--	-------------------------------	---



**Do not use the stove or boiler flame to light cigarettes, candles, etc.**



**The use of flexible flues, especially aluminum ones, is prohibited as there is a risk of fire.**

**Pellets** must be stored in a dry environment that is not too cold.

It is recommended that **pellet** bags be stored in areas where the temperature and humidity are acceptable.

Cold **pellets (<5°C)** reduce the thermal capacity of the fuel and require better cleaning of the firebox and the entire combustion chamber.

## **6.0 Maintenance and cleaning**

Disconnect and allow the stove to cool before any maintenance or cleaning. Make sure that the ashes in the ash pan are extinguished. Always use appropriate commercial tools for maintenance (cleaning brushes, consumables, small tools, etc.). After maintenance is complete and before putting the stove back into operation, check that all parts have been returned to their original positions and that all protective systems are in place. Only use genuine or authorized spare parts. Some pellet brands produce more dust and clinker. Therefore, the frequency of stove cleaning depends largely on the quality of the pellets. Failure to clean the stove will reduce combustion efficiency and void the warranty.



**If you install parts and accessories that don't meet the company's specs, the warranty will be void.**



**Any modification or replacement of a device component must be carried out in accordance with the manufacturer's instructions and approval. The company bears no responsibility for any interventions or modifications to the unit without its written approval.**

## 6.2 Cleaning the combustion chamber

The combustion fan operates at high speed and blows combustion by-products out of the combustion chamber every hour. However, the combustion burning chamber must be thoroughly cleaned after approximately 10 bags of pellets. Extreme temperatures in the combustion chamber can cause dust and clinker to form.

Once the stove has cooled down, open the front door and remove the combustion chamber. Scrape the inside bottom and sides of the combustion chamber to remove all dust and clinker. Make sure that the high side of the firebox is facing the front of the stove. Push the firebox downwards. Do not replace the firebox with another firebox. Refer to figure 6.1-1.

---

---

## 6.3 Glass cleaning



**CAUTION: Do not open the front door until the stove has cooled completely.**

Clean the glass using a soft cloth or a special professional glass cleaning cloth.

## 6.4 Moving and cleaning the ash pan



**CAUTION: Do not move the ash pan when the stove has not cooled down completely.**

Ashes must be disposed of in a metal container with a tight-fitting lid. The closed container must be placed on a non-flammable floor or on the ground away from all flammable materials, and then the waste must be disposed of, after first ensuring that nothing is still burning and that the ashes have cooled down. Replace the ash container and reassemble it

carefully. Please note that if the ash container is not sealed properly, the control board may detect this and turn off the stove.

## 6.5 Cleaning

During combustion, small particles of fly ash are collected in the ventilation system and affect the flow of exhaust gases. Incomplete combustion, such as when starting, shutting down, or malfunctioning the stove, leads to soot formation. This soot is collected in the ventilation system. The ventilation system should be checked at least once a month to see if it needs cleaning. Clean the duct as needed.

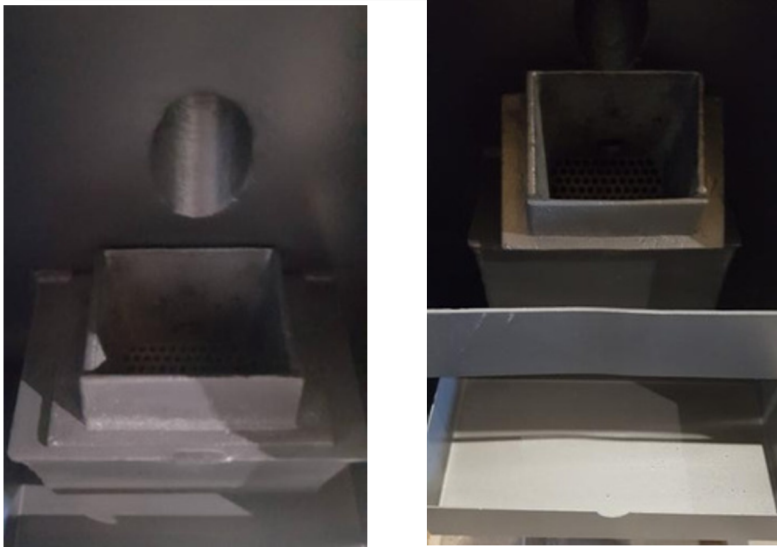

**Figure 6.6 Photo of the interior of ANGELA TA**

It is recommended to frequently remove the ash that remains inside the grate by pulling the container located under the grate using the appropriate handle (**Figure 41**). The excess ash is stored in the drawer under the grate, which can be pulled out and cleaned whenever necessary. Using a vacuum cleaner can facilitate the cleaning process. Place the ashes

should be placed, when cold, in a non-flammable container away from flammable materials, in an area outside the home.

Clean the glass with a damp cloth or using suitable cleaning products. Never use sponges or detergents that can scratch the glass.

## 6.6 Periodic cleaning of the ANGELA air stove

-General internal cleaning of the exchanger from the inside of the combustion chamber at the top and at the back, on the opposite side, at the exhaust pipe cap. (Figure 5.2)

-Clean the grate and combustion chamber.

-Clean the smoke chamber through the inspection cap on the left side and the **ventilator** on the right side of the stove.

-Check the exhaust sensor.

-Check and clean the fresh air intake pipe.

-Check the operation of the ignition resistors.

-Visual inspection of electrical cables, connections, and power cord.

-Cleaning the **pellet** container and checking the pellet feed screw

- Check and clean the flue pipe and its accessories.

- Cleaning the inside of the door windows.



**Figure 5.2 – Detail (TA Angela)**

### **6.6.1 Annual cleaning of ANGELA air stove**

Annual cleaning must be carried out by specially trained technical personnel, following these instructions: Annual cleaning is necessary if periodic cleaning is not carried out. During the annual cleaning, we have time to not only clean the stove but also perform maintenance by checking and repairing possible causes of problems, e.g., worn cables, burnt glass cord sections, etc. Chimney cleaning is also required.

### **6.7 Cleaning program for components according to pellet usage (Standard: 15kg/bag)**

Combustion chamber	5 bags	Exhaust fan	100 bags
Ash container	10 bags	Room fan	50 bags

**⚠ CAUTION: Cleaning schedule depends on pellet quality. Pellets with high ash content require more frequent cleaning.**

## 7.0 Electrical connections

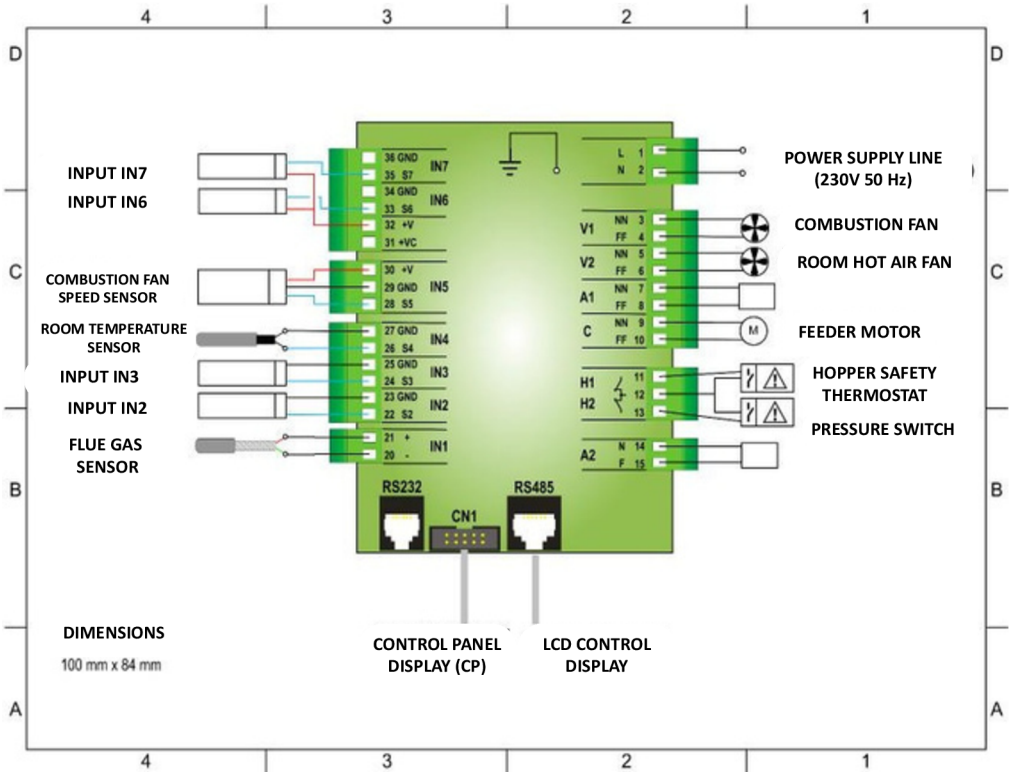

PIN		OPERATION	FEATURES [NG01]
1	L	Power Supply	230 Vac ± 10% 50/60 Hz
2	N		
3	NN	Combustion fan Room Heating Fan	Triac Regulation 0.9 A max
4	FF		
5	NN		
6	FF		
9	NN	Pellet Screw Motor	Triac Regulation 0.9 A max
10	FF		
1		Tank Safety Thermostat	Contact ON/OFF Normally closed Bypass if not used
1		AT1 Input	
1		Exhaust Pressure Switch AT2 Input	Contact ON/OFF Normally closed To Bypass if not used
2			
	1		
	2		
20	2 Green -	Exhaust Gas Temperature Sensor	Thermocouple K: 500 or 1200 o C max
21	1 Red +		
22	3 SEG	Configurable Input IN2 (parameter: P77)	Analog input (probe NTC 10K)/digital
23	3 GND		
24	SEG		
25	GND	Configurable IN3 (Parameter: P75)	Analog input (probe NTC 10K)/digital
	2	Room temperature sensor	NTC 10K @25 oC: 120 oC Max
	27		
28	SEG	Rotation Control	Signal TTL 0/5 V - -
29	GND		
30	+V		
31	+Vc		
		+10 ÷14 Volt	Input
32	+V	+5 Volt	/digital
33	SEG	Configurable Input IN6 (parameter: P78)	Input analog
34	GND		
35	SEG		Connection for analog Programmer, KeyPro, Modem, PC
36	GND		
RS232			
RS485			Connectionfor LCD control panel, 4Heat

<b>CN1</b>	Connection for CP control panel
------------	---------------------------------

## 8.0 Control Panel: Use and Functions

LED		
LED	Steady	Flashing
<b>L1</b>	Phase Stabilization	Ignition start
<b>L3</b>	Stove off	Phase Shutdown
<b>L4</b>	Operation	Stabilization / Standby
<b>L5</b>	Motor Screw ON	
<b>L6</b>	Resistance ON	
<b>L7</b>	Time Activation	
<b>L8</b>	Fan Room ON	
Display		
Display	Steady	Flashing
<b>D1</b>	Time	
<b>D2</b>	Scale Operation	Change Scale Operation
<b>D3</b>	Thermost at Setting Room	Change Temperature

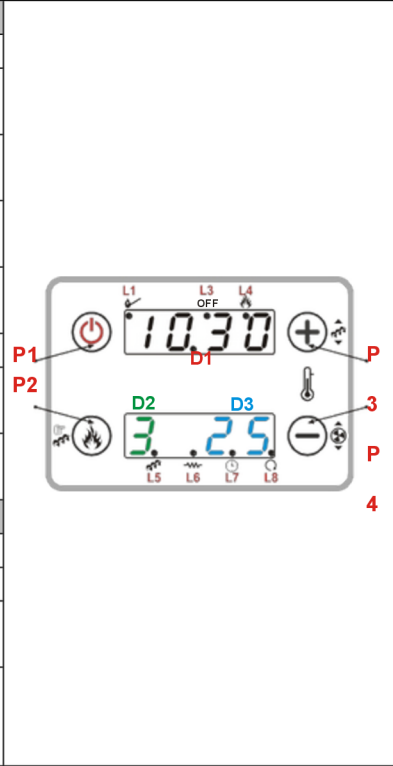

Keys		
Tasto	Click [One press]	Long press
<b>P1</b>	Function Indicator	Start/Stop/Reset from error
<b>P2</b>	Scale adjustment Operation	Manual Pellet Loading
<b>P</b>	Adjustment Temperature (+)	Pellet Feed Adjustment
<b>P4</b>	Setting Temperature (-)	Combustion Air Setting

## ERROR CODES

DESCRIPTION	HOW TO FIX	INDICATION
Overheating of Tank / Faulty Sensor on PIN11/12	Check Tank Sensor Check & Replace Sensor	Er01
Gas Safety Pressure Switch on PIN13/14	Clean / Check for blocked flue	Er02
Ignition failure because of low exhaust gas temperature	Possible Auger Blockage Possible Lack of Pellets	Er03
Ignition failure because of high exhaust gas temperature	Clean & Adjust Device settings	Er05
Fault detected in the combustion fan speed sensor	Clean / Check Fan Speed sensor of the flue gases	Er07
Combustion fan speed control failure	Check Combustion Fan Check Chimney	Er08
Ignition Failure	Low Exhaust Temperature Restart the Device	Er12
Power Failure		Er15
Lack of Pellets		Er18
Incorrect Date and Time		Er11
Faulty Sensor	Check / Replace Sensor	50nd

**Reset of the error is done by pressing the adjacent P1 button.**

**User Menu (1)**

**Power On/Off**  
 The ignition is activated by pressing and holding the **P1** button.  
 Ignition is indicated by the lighting of LED **L1**  
 The operating status is indicated by the steady lighting of LED **L4**  
 Standby mode is indicated by the LED **L4** flashes  
 Switching off is activated by pressing and holding the **P1** button  
 Switching off is indicated when LED **L3** flashes  
 The end of the extinguishing process is indicated by the LED **L3**

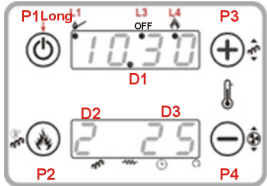

**Combustion Power Setting**  
 Press the **P2** button: the **D2** display flashes.  
 The next time you press the **P2** button, the power changes according to the following values  
 : **1 – 2 – 3 – 4 – 5 – A** (A= Automatic power)  
 After 3 seconds, the change is registered.

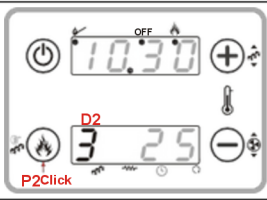

**Room Temperature Setting (1)**  
 Press the **P3** or **P4** button: the display **D3** flashes.  
 Each subsequent press of the **P3 / P4** buttons increases or decreases accordingly.  
 After 3 seconds, the change is saved

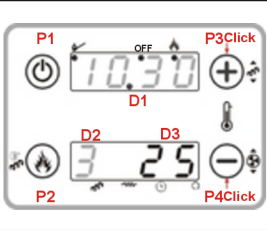

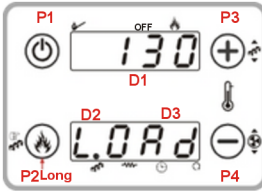
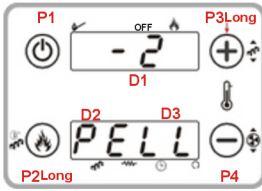
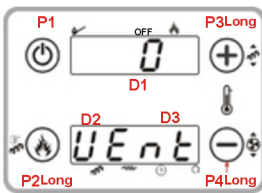
'Manual' Pellet Loading (2)	
<p>Pressing and holding the <b>P2</b> button activates "manual" pellet loading, putting the feed motor into continuous operation. The lower display shows the power and the upper display shows the operating time. To turn off the power, press any key. The power is automatically turned off after 300 seconds.</p>	 <p>The control panel features a digital display with two sections. The upper section shows the number '130' and the label 'D1'. The lower section shows 'LORd' and the label 'D2'. The panel includes several buttons: a power button (P1), a plus button (P3), a minus button (P4), and a long-press button (P2Long). There are also icons for a flame and a thermometer.</p>
Pellet Feed Setting (3)	
<p>Press <b>and hold</b> the <b>P3</b> button twice, <b>and on the third time it will flash, and then</b> use the <b>P3 / P4</b> buttons to change the value accordingly.  The lower display shows <b>PELL</b>  The <b>D1</b> display shows the value that is changing and flashes.  The range of change is <b>- 7 + 7</b>. The default value is '0'.  After 3 seconds, the change is registered.</p>	 <p>The control panel shows the upper display with '-2' and 'D1', and the lower display with 'PELL' and 'D2'. The buttons and icons are the same as in the previous image.</p>
Combustion Air Adjustment (3)	
<p>Activation is performed by pressing and holding the <b>P4</b> button  The lower display shows the <b>UEnt</b> indicator  The <b>D1</b> display shows the value that changes and flashes  The value is changed using the <b>P3 / P4</b> buttons The change range is <b>- 7 ÷ 7</b>. The default value is '0'  After 3 seconds, the change is registered.</p>	 <p>The control panel shows the upper display with '0' and 'D1', and the lower display with 'UEnt' and 'D2'. The buttons and icons are the same as in the previous images.</p>

- (1) When the selected temperature is lower than the room temperature measured by the device (indication tA 3.7), the device does not start operating.
- (2) After the manual loading process, make sure that the device's burner is empty before starting the device.
- (3) Changes to these settings must be made with caution, as they alter the fuel/air ratios of combustion. **Do not change the values arbitrarily.**

## Display

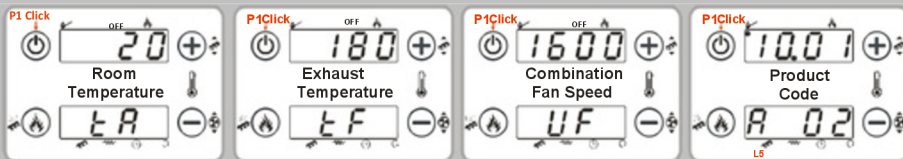

By pressing the **P1** key.

**tA** = Room Temperature

UF= Combustion Fan Speed [RPM/Volt]

**tF** = Exhaust Gas Temperature

**A 02**=Product Code

## Remote control (Optional)











**The ON button turns the device on, the OFF button turns it off.**

Use the + / - buttons to increase or decrease the flame intensity and operating levels.

### On the device:

- Set the remote control function to ON.  
Press the P2 / P4 buttons simultaneously. Use the + button to find the "tele" setting and set it to ON.



<b>User Menu (2)</b>	
<b>Date and Time Setting</b>	
<p><b>Time Setting</b>            Press the <b>P2 &amp; P4</b> buttons simultaneously for 3 seconds to enter menu (2). The display shows: Cron</p> <p>-Press <b>P3</b>. The display shows: DATE </p> <p>-Press <b>P2</b> and the time will be displayed</p> <p>-Press <b>P2</b>. The hour digits will flash. Use the arrow keys (P3 &amp; P4) to set the correct time.</p> <p>-Confirm by pressing <b>P2</b>.</p> <p>-Press P2 again. The day flashes. Use the arrows (P3 &amp; P4) to set the correct day.</p> <p>-Confirm by pressing <b>P2</b>.</p> <p>-To exit, press the <b>P1</b> button</p>	
<p><b>Timer</b>            Allows you to program switching on/off</p>	
<p><b>Activation</b>            Activates the specified program. Press the <b>P2</b> button to enter.            Press the <b>P3/P4</b> buttons to select            ON=activate the program OFF=deactivate the program            To confirm, press the <b>P2</b> button, or press <b>P1</b> to exit.</p> <p><b>Program</b>            You can program 3 time zones during each day.</p>	
<p>Select </p> <p>Press the <b>P2</b> button to enter. Use the <b>P3/P4</b> buttons to view the programmed zones:</p> <p>The upper display shows the SELECTED TIME-----If the zone is disabled</p> <p>The lower display shows: DAY / ZONE / ON/OFF</p> <p>Pressing and holding the P1 button Activates / Deactivates the selected zone.</p>	  
<p style="text-align: center;"><b>PROGRAMMING AFTER MIDNIGHT</b></p> <ul style="list-style-type: none"> <li><input type="checkbox"/> Activate the <b>ON</b> time for the previous day: Example 20:30</li> <li><input type="checkbox"/> Activate the <b>OFF</b> time for the previous day: <b>23:59</b></li> <li><input type="checkbox"/> Activate the <b>ON</b> time for the next day: <b>00:00</b></li> <li><input type="checkbox"/> Activate the <b>OFF</b> time for the next day at the desired time: e.g. 6:30</li> </ul> <p>For example, the device will turn on on TUESDAY at 20:30 and turn off on WEDNESDAY at 6:30</p>	   

## INSTALLATION INSTRUCTIONS

**IT IS ABSOLUTELY ESSENTIAL THAT THE DEVICE IS INSTALLED BY LICENSED INSTALLERS AND THAT THE FOLLOWING IS OBSERVED:**

- THE ELECTRICAL CONNECTION OF THE DEVICE MUST BE PERFORMED BY A LICENSED ELECTRICIAN
- **MINISTERIAL DECISION 189533/2011 MUST BE APPLIED.**
- THE INSTALLATION OF THE CHIMNEY IS **ABSOLUTELY NECESSARY** TO BE IN ACCORDANCE WITH THE **E.L.O.T. 447 DIN 4705** REGULATION FOR THE PROPER, **SAFE AND ECONOMICAL OPERATION** OF THE DEVICE.
- THE APPLIANCE MUST OPERATE WITH A MINIMUM OF 2.5m VERTICAL CHIMNEY AND A MAXIMUM OF TWO CHANGES IN DIRECTION AND A MAXIMUM HORIZONTAL SECTION OF HALF A METER. FOR EACH ADDITIONAL CHANGE OF DIRECTION OR ADDITIONAL HORIZONTAL SECTION OF ONE METER, 1.5m OF VERTICAL CHIMNEY MUST BE ADDED. IF THE CHIMNEY EXCEEDS A TOTAL OF SEVEN METERS, IT IS RECOMMENDED TO REPLACE IT WITH Ø 80 WITH Ø100.
- THE EXTERNAL PARTS OF THE CHIMNEY MUST BE INSULATED.
- **THE USE OF FLEXIBLE AIR DUCTS FOR CHIMNEYS IS PROHIBITED.**
- IF THE DEVICE IS INSTALLED INDOORS, IT IS **ABSOLUTELY NECESSARY** TO CONNECT THE **FRESH AIR SUPPLY** TO THE REAR OF THE UNIT OR INSTALL A TO BALANCE THE INTERNAL SUCTION.
- WHEN INSTALLING THE DEVICE, MAKE SURE THERE IS AT LEAST **40cm OF SPACE** ON THE SIDES AND BEHIND FOR SAFETY, MAINTENANCE, AND SERVICE (SEE INSTALLATION INSTRUCTIONS) BEFORE STARTING
- THE DEVICE, CHECK THE QUALITY OF THE FUEL (PELLETS/BRICKS/WOOD). SOLID FUELS MUST BE STORED IN A DRY AND COVERED AREA
- THE FIRST IGNITION OF THE DEVICE MUST BE PERFORMED BY A LICENSED INSTALLER, IT MUST BE PERFORMED BY A LICENSED INSTALLER WHO WILL ALSO BE RESPONSIBLE FOR ITS OPERATION.
- THE DEVICE IS INSTALLED AND MAINTAINED BY LICENSED INSTALLERS AND MAINTENANCE TECHNICIANS.
- THE COMPANY IS NOT RESPONSIBLE FOR INCORRECT INSTALLATION AND FAILURE TO FOLLOW THE INSTALLATION INSTRUCTIONS AND USE OF NON-CERTIFIED FUEL (PELLETS/BRICKS/WOOD)
- TO SELECT THE TYPE AND POWER OF THE DEVICE, IT IS ESSENTIAL TO HAVE THE HEAT LOSS OF THE SPACE STUDIED BY AN EXPERIENCED AND RESPONSIBLE ENGINEER. OR LICENSED INSTALLER WHO WILL ALSO BE RESPONSIBLE FOR THE SELECTION
- THE COMPANY MIK EUROPE -MYTHERM GUARANTEES THE DEVICE AND IS REQUIRED BY LAW TO COVER MANUFACTURING AND MATERIAL DEFECTS IN ACCORDANCE WITH THE PROVIDED WARRANTY FOR THE SPECIFIED PERIOD, TO MAINTAIN A STOCK OF SPARE PARTS AND ACCESSORIES, TO TRAIN AND EDUCATE THE INSTALLERS AND MAINTENANCE TECHNICIANS OF THE DEVICES WITH SEMINARS AND TO PROVIDE THEM WITH TELEPHONE SUPPORT AND TRANSPORTATION **TO THEM AND ONLY TO THEM** WHEN THE NEED ARISES. THE COMPANY DOES NOT HAVE THE MEANS TO INSTALL AND MAINTAIN THE DEVICES OR TO REPAIR THE DEVICES AT THE USER'S PREMISES, NOR CAN IT ADJUST, REPAIR, OR AND TO REPAIR THE DEVICES BY PHONE. THIS POSES THE RISK OF FURTHER DAMAGE. THE TELEPHONE ASSISTANCE PROVIDED BY THE COMPANY IS PROVIDED IN GOOD FAITH, AT THE USER'S OWN RISK AND **DOES NOT IN ANY WAY REPLACE THE DEVICE MAINTENANCE TECHNICIAN.**

□ THE COMPANY MANUFACTURES AND SELLS IN ACCORDANCE WITH EUROPEAN ISO - CE-EN REGULATIONS - IN THIS CONTEXT, IT IS ABSOLUTELY NECESSARY, FOR THE WARRANTY TO BE VALID, TO ACCEPT AND COMPLIANCE WITH THE ABOVE AND THE SENDING OF THE FOLLOWING TO THE COMPANY. 1. WARRANTY FORM 2. STATISTICAL CONTROL FILE (COMPLETED) 3. CHIMNEY SWEEP FORM. THE COMPANY IS NOT OBLIGATED TO PROVIDE ANY ASSISTANCE OR INFORMATION FOR DEVICES FOR WHICH IT HAS NOT RECEIVED THE ABOVE FORMS.